



**Nickel Metal Hydride**

A large, semi-circular graphic on the left side of the page, filled with various green and yellow technical patterns, including circuit board traces, grid lines, and abstract geometric shapes. The text 'Technical Hand Book' is overlaid on this graphic in white.

**Technical  
Hand Book**

# Table of Contents

<b>1 Introduction</b> .....	<b>3</b>		
1.1 Overview .....	3		
1.1.1 Chemistry - The Early Days .....	3		
1.1.2 Well Established Product Series .....	3		
1.2 NiMH Chemistry .....	3		
1.2.1 Principle .....	3		
1.2.2 Positive Electrode Chemistry .....	3		
1.2.3 Negative Electrode Chemistry .....	4		
1.2.4 Overall Reaction .....	4		
1.2.5 Cell Pressure Management - Charge Reserve .....	4		
1.2.6 Minimizing Damage During Deep Discharge - Discharge Reserve .....	5		
1.3 Cell Construction .....	6		
<b>2 Performance Characteristics</b> .....	<b>7</b>		
2.1 Charging Characteristics .....	7		
2.1.1 Overview .....	7		
2.1.2 Charging Efficiency .....	7		
2.2 Discharge Characteristics .....	8		
2.2.1 Overview .....	8		
2.2.2 Discharge Voltage .....	8		
2.2.3 Discharge Capacity .....	8		
2.2.4 Polarity Reversal During Over-discharge .....	8		
2.3 Storage Characteristics .....	9		
2.3.1 Overview .....	9		
2.3.2 Storage Temperature .....	9		
2.3.3 Storage Time .....	9		
2.3.4 Storage Humidity .....	10		
2.4 Cycle Life .....	10		
2.4.1 Overview .....	10		
2.4.2 Ambient Temperature .....	10		
2.4.3 Overcharge .....	10		
2.4.4 Deep Discharge .....	10		
2.5 Safety .....	10		
2.6 Characteristics of Various Series .....	10		
2.6.1 Standard Series .....	11		
2.6.2 High Drain Series .....	11		
2.6.3 High Temperature Series .....	11		
<b>3 Charging Method</b> .....	<b>12</b>		
3.1 Overview .....	12		
3.2 Charging Method .....	12		
3.2.1 Constant Current Charging .....	12		
3.2.2 Fast Charging .....	12		
3.2.3 Charge Control .....	12		
3.2.4 Standard Charge .....	13		
3.2.5 Trickle Charging .....	13		
3.2.6 Charging Temperature .....	13		
<b>4 Battery Assembly</b> .....	<b>14</b>		
4.1 Connection Between Cells .....	14		
4.2 Thermal Protection for Battery Packs .....	14		
<b>5 Configurations</b> .....	<b>15</b>		
<b>6 Proper Use and Handling</b> .....	<b>16</b>		
6.1 Restriction On Usage .....	16		
6.1.1 Charging / Discharging Current .....	16		
6.1.2 Reverse Charging .....	16		
6.1.3 Parallel Charging .....	16		
6.1.4 Charging / Discharging Temperature .....	16		
6.1.5 Over-discharging / Overcharging .....	17		
6.2 Precautions for Designing Application Devices .....	17		
6.2.1 Battery Compartment .....	17		
6.2.2 Charging / Discharging / Operating Temperature .....	17		
6.3 Methods of Use .....	17		
6.3.1 Operation .....	17		
6.3.2 Connection Between Battery and Application Devices .....	17		
6.4 Precautions in Battery Handling .....	18		
6.5 Battery Maintenance .....	18		
6.5.1 Regular Inspection .....	18		
6.5.2 Storage .....	18		
6.5.3 Battery Disposal .....	18		
6.5.4 Transportation .....	18		
<b>7 Customer Application Questionnaire</b> .....	<b>19</b>		
<b>8 Glossary</b> .....	<b>21</b>		

## NOTICE TO READERS

The information in this technical handbook is generally descriptive only, and is not intended to make or imply any guarantee or warranty with respect to any cells and batteries. Cell and battery designs are subject to modification without prior notice. Performance of a battery should be based on its corresponding data sheet and product specification.

# 1 Introduction

## 1.1 Overview

### 1.1.1 Chemistry - the early days

Nickel metal-hydride (NiMH) technology has been used commercially since the early 1990's, mainly with consumer applications. At the time, nickel cadmium (NiCd) was the mainstream technology to which NiMHs was often compared. Even in the early days, it was recognised that NiMH batteries not only able to achieve higher energy density than NiCds, also more environmentally friendly.

Since both systems employed 1.2V in nominal voltage and also share many performance characteristics, it was relatively easy to adapt NiCd applications for use with NiMH.

Subtle differences between the two chemical systems made direct substitution of NiCd by NiMH a difficult process. Differences in the charging curve profiles meant that modification was required for fast charging of NiMH batteries. The early NiMH batteries were generally considered weaker in charge retention performance, and were not deemed suitable for high-drain applications.

### 1.1.2 Well established product series

Over the years, there have been significant improvements in NiMH technology, with most of the early weaknesses now eliminated. NiMH batteries of today outperform NiCds in many areas, including continued advances in energy density. There are now NiMH batteries that have twice the energy density of similar-sized NiCds, and many new applications are designed specifically for NiMH battery use, including: cellular phones, camcorders, audio-visual equipment, toys, laptop computer and personal care products.

GP NiMH rechargeable batteries had long been established as a well-known choice that offers performance, reliability and value. We have expanded our NiMH product range into various series to custom fit various application requirements.

-- the ever popular **standard series** is designed for a wide variety of general applications, including toys, personal audio equipment, cameras and cordless phones.

-- for capacity demanding applications, our **high capacity series** is available. This has been achieved through revolutionary designs in mechanical construction and new chemical formulation.

-- the **high-temperature series** is designed for applications whereby the battery may encounter elevated temperature during operation. Special designs ensure that the battery performance is stable and reliable under adverse environmental conditions. Emergency lighting is one of such applications best served by the high-temperature series.

-- the **high-drain series** is expertly customized for powerful delivery of electrical energy on demand. Power tools and electric bicycles are among some of the applications that excel with our high-drain series as power sources.

## 1.2 NiMH Chemistry

### 1.2.1 Principle

As with any other rechargeable battery system, NiMH batteries operate on the principle that electrochemical reactions at each of the electrodes are reversible; this enables energy to be stored during charging and released during discharging.

### 1.2.2 Positive electrode chemistry

The reaction that occurs at the positive electrode of a NiMH battery is the same as that for its NiCd counterpart:

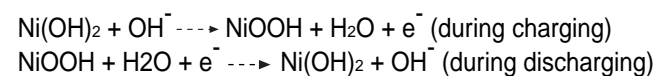

Ni(OH)<sub>2</sub> and NiOOH are viewed as a reversible couple, able to transform from one to the other, depending on whether charging or discharging is in effect.

During the charging operation, electrical energy provided from an external power source is stored as chemical energy in the cell, when the lower energy Ni(OH)<sub>2</sub> is converted to the higher energy NiOOH. During a discharge reaction, the NiOOH is converted back to Ni(OH)<sub>2</sub>, releasing the stored chemical energy as electrical energy.

### 1.2.3 Negative electrode chemistry

The active material in the negative electrode is an alloy, which can reversibly absorb and release hydrogen atoms. There is no free hydrogen gas involved in the charging and discharging of the electrode.

There are two basic types of hydrogen-storage alloys available for NiMH batteries. One type consists of transition metals, such as titanium and zirconium, often referred to as the AB<sub>2</sub> alloys. The second type is made up of the rare-earth elements such as lanthanum, known as the AB<sub>5</sub> alloys.

The following reactions occur during the charge and discharge operations:

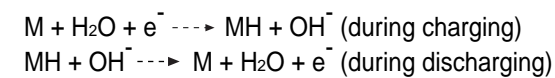

In the equations above, M represents the hydrogen-storage alloy. MH is formed when hydrogen atoms, from the electrolysis of water, are absorbed by the alloy M. Upon discharge, the hydrogen atom is released and converted back to water.

### 1.2.4 Overall reaction

Combining the equations in 1.2.2 and 1.2.3 reveals the overall cell equation.

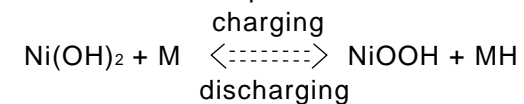

The overall reaction schematically depicts a simple transfer of H atom between Ni(OH)<sub>2</sub> and M, depending on whether the cell is being charged or discharged.

### 1.2.5 Cell pressure management - charge reserve

Up till now, only those reactions involving the main charging and discharging process have been shown. However, when a NiMH cell is close to being fully charged, gas-generating side reactions start to develop. For hermetically sealed batteries, if the side reactions are not prevented, the internal pressure may become excessively high.

In sealed NiMH as well as NiCd batteries, the internal pressure is designed to remain at safe levels during operation. The main principle is to

ensure that the capacity of the negative electrode exceeds that of the positive electrode. The excess capacity in the negative electrode is referred to as the charge-reserve of the cell. With the proper designs, the positive electrode is always the capacity-limiting electrode. As the cell approaches full charge, oxygen gas will start to evolve from the positive electrode in the process of electrolysis.

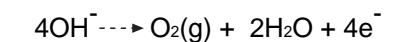

However, due to the excess capacity (charge-reserve) in the negative electrode, the corresponding electrolysis product of hydrogen will be prevented from forming. Instead, the oxygen gas from the positive electrode diffuses to the negative electrode and is consumed in the oxygen recombination reaction.

The oxygen recombination at the negative electrode occurs simultaneously, via two reaction mechanisms:

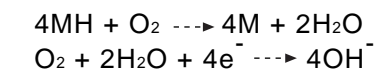

The first equation represents a direct combination of the O<sub>2</sub> gas with MH, which is present in significant amounts at the negative electrode of a fully charged battery. The second equation is a reverse of the electrolysis reaction that originally generated the O<sub>2</sub> at the positive electrode. The end result of these two equations is that gaseous O<sub>2</sub> is reabsorbed by the negative electrode, thereby preventing unacceptably high internal pressure during the charging reactions.

In addition, most hermetically sealed rechargeable batteries are equipped with resealable or non-resealable (one time) venting systems, which safely release any internal pressure that might have built up when the batteries were exposed to unexpectedly severe conditions of operations.

**1.2.6 Minimising damage during deep discharge - discharge reserve**

In the event of deep discharge, depreciation of battery performance may occur. To minimise the possibility of damage, the excess capacity in the negative electrode also acts as discharge-reserve, preventing the negative electrode from being oxidised in the event that the battery is deeply discharged.

The relationship between the useful capacity, charge reserve and discharge reserve is shown in the following schematic representation.

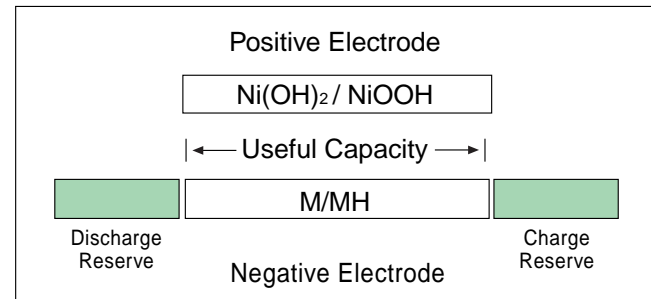

**1.3 Cell Construction**

**Cylindrical**

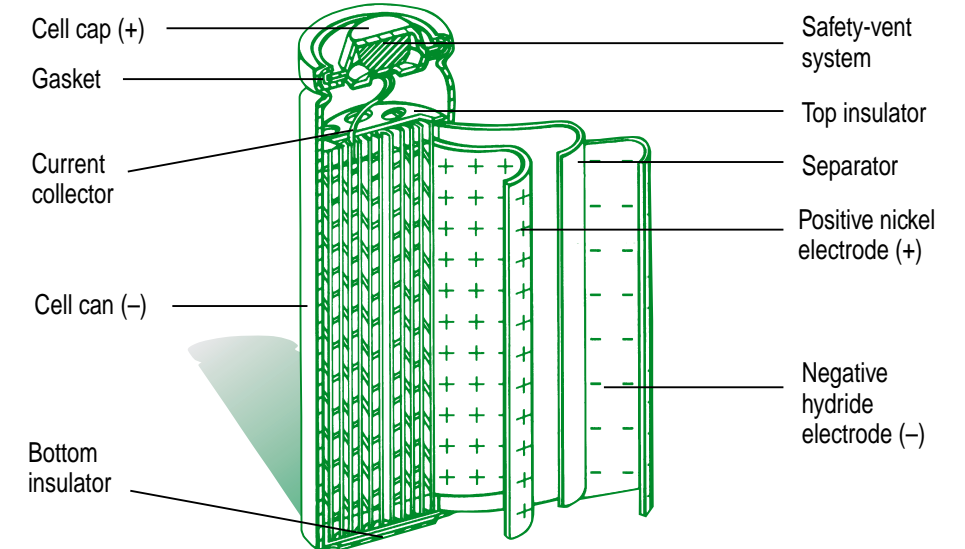

**9V**

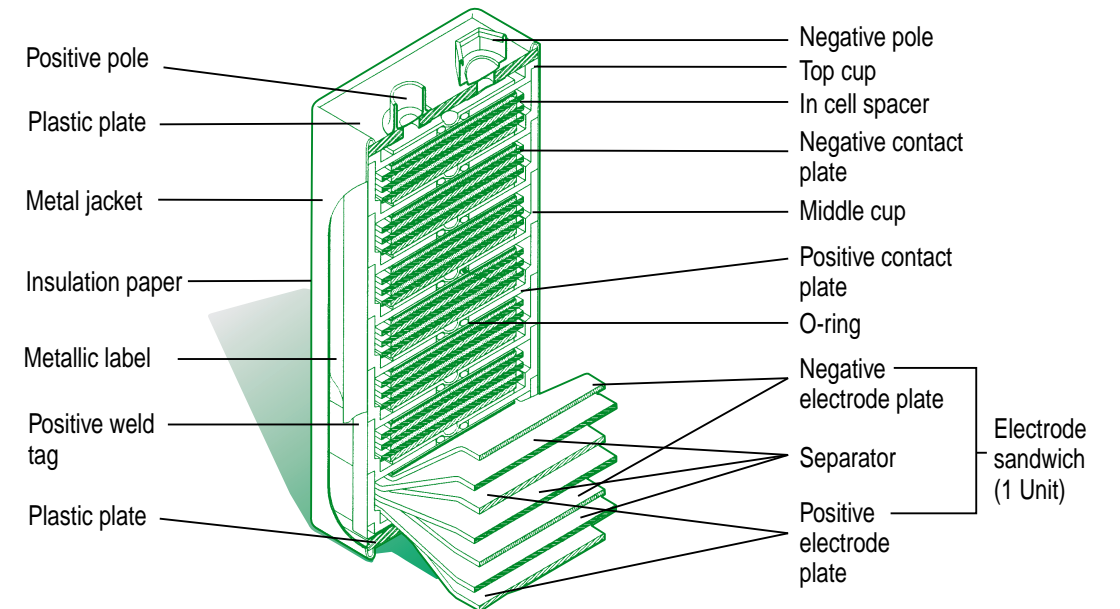

**Prismatic**

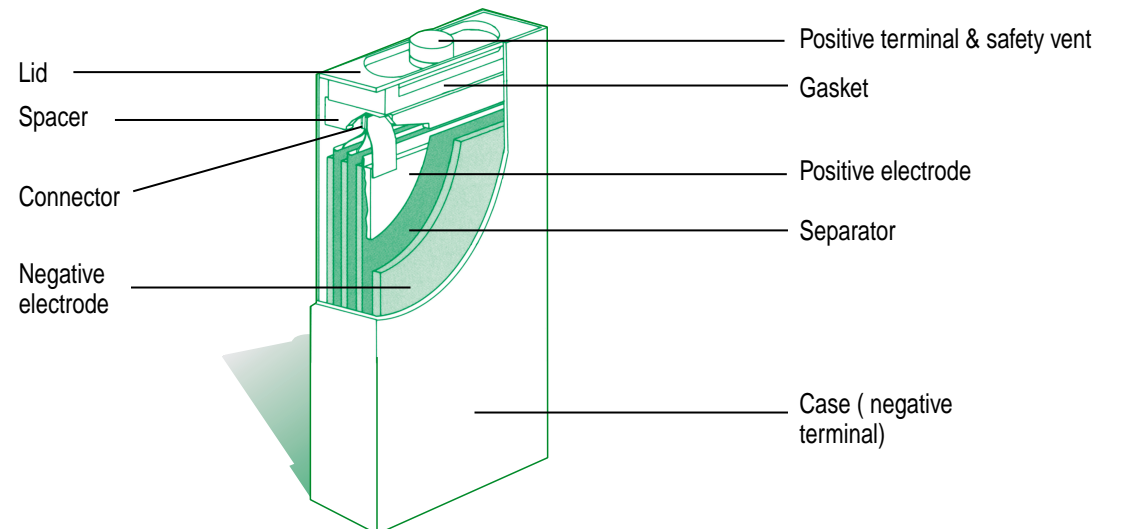

# 2 Performance Characteristics

## 2.1 Charging Characteristics

### 2.1.1 Overview

The charging process aims to restore the battery for use by charging the battery externally. The charge voltage is affected by current, ambient temperature and time. At the same ambient temperature, the basic principle is: the higher the current, the higher the charge voltage as a result of increased over-potential at both electrodes.

When almost fully charged, peak voltage is attained. However, if the battery is overcharged, a slight decrease in voltage occurs; this arises from a temperature increase due to the exothermic oxygen recombination reaction. As a result, internal pressure builds up and heat is generated during overcharging. At a low charge rate (such as 0.1C or below), equilibrium pressure can be attained through a balanced electrode design. In addition, heat generated during overcharging is dissipated into the environment. The battery temperature is also affected by the current and ambient temperature.

### 2.1.2 Charging efficiency

In general, it is more efficient to charge the battery at or below room temperature, since the chemicals of both positive and negative electrodes are more stable at lower temperatures - resulting in higher discharge capacity. The charging efficiency of standard series NiMH batteries drops rapidly when the ambient temperature exceeds 40°C. Furthermore, the decrease is more pronounced at low charging rates, since the return of electrode chemicals to their lower charge state is more evident. The high temperature series, on the other hand, allow applications of trickle charge at temperatures as high as 70°C. The technology is a result of dedicated research by GP to enhance the stability of battery materials at high temperatures.

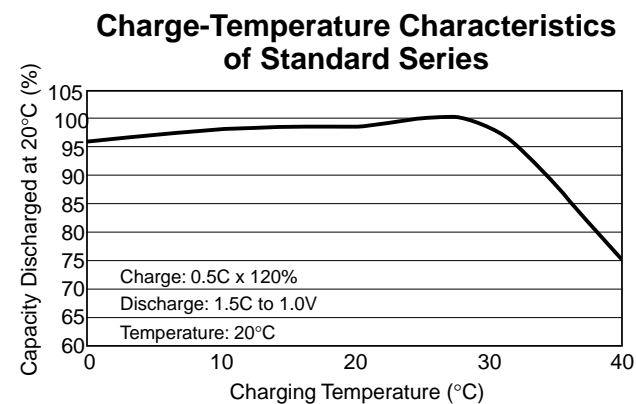
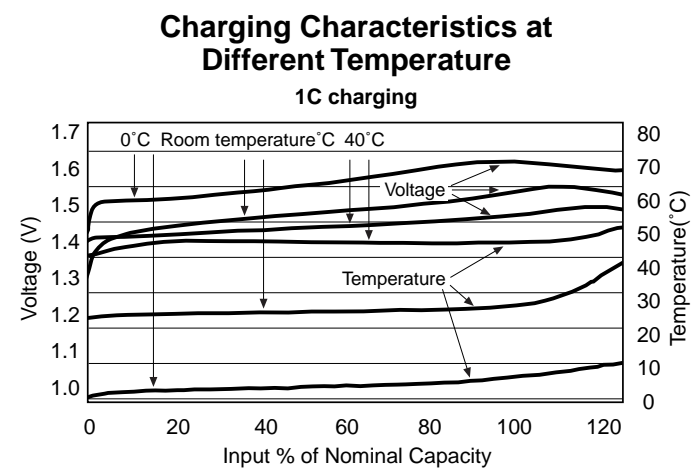
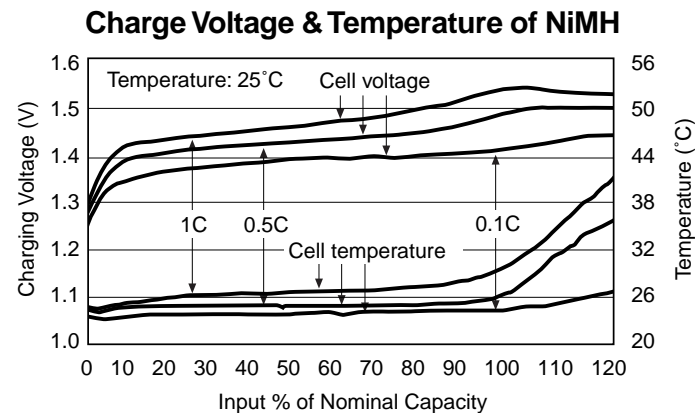

## 2.2 Discharge Characteristics

### 2.2.1 Overview

The nominal discharge voltage of a NiMH battery is 1.2V at 0.2C discharge, which is almost identical to that of a NiCd battery. The discharge time of a NiMH cell is almost 1.5 times that of the NiCd cell of same size, due to the high energy density of NiMH batteries.

### 2.2.2 Discharge voltage

The discharge voltage is affected by current and ambient temperature. Like NiCd batteries, the discharge voltage of NiMH batteries is depressed at lower temperatures. This is because both NiCd and NiMH batteries employ an aqueous electrolyte system, resulting in decreased ionic mobility at lower temperatures. At higher currents, the discharge voltage of NiMH batteries is depressed, since the metal-hydride electrode is more polarised.

Previously, most NiMH cell manufacturers recommended 3C as the maximum discharge current; otherwise the discharge voltage would have simply been too low for many applications. As a result of advancements in NiMH battery technology, the discharge current achieved by some of the latest NiMH batteries can now achieve as high as 10C.

### 2.2.3 Discharge capacity

The discharge capacity is defined as "the product of discharge current and discharge time when the battery reaches the end discharge voltage." The nominal discharge capacity is rated at 0.2C to an end voltage of 1V after charging at 0.1C for 14 - 16 hours.

The discharge capacity is also affected by discharge current and ambient temperature. Capacity decreases with decreased temperature due to lower reactivity of the active materials and higher internal impedance. At a higher discharge current, the usable capacity is reduced due to larger IR drop, and also because the battery voltage drops off more rapidly to end voltage.

### 2.2.4 Polarity reversal during over-discharge

Most real-life applications employ multi-cell, series - connected batteries. When discharging, the lowest capacity cell will be the first to experience a voltage drop. If the battery discharge continues, this unit cell will be driven into an over-discharged condition. When the cell voltage drops below 0V, its polarity is effectively reversed. The cell reaction, at different stages, is illustrated below:

**Stage 1:** Initially, both positive and negative electrodes, as well as the discharge voltage are normal.

**Stage 2:** The active material on the positive electrode has been completely discharged and evolution of hydrogen occurs. Cell pressure builds up, although part of the gas can be absorbed by the negative metal alloy electrode. Since the battery is designed with excess negative capacity (discharge reserve), the discharge continues; discharge voltage is around -0.2V to -0.4V.

**Stage 3:** The active material on both electrodes has been depleted and oxygen generation starts at the negative electrode. Formation of gases at both electrodes leads to high internal cell pressure and opening of the safety vent, resulting in deterioration of the cell performance if this scenario occurs repeatedly.

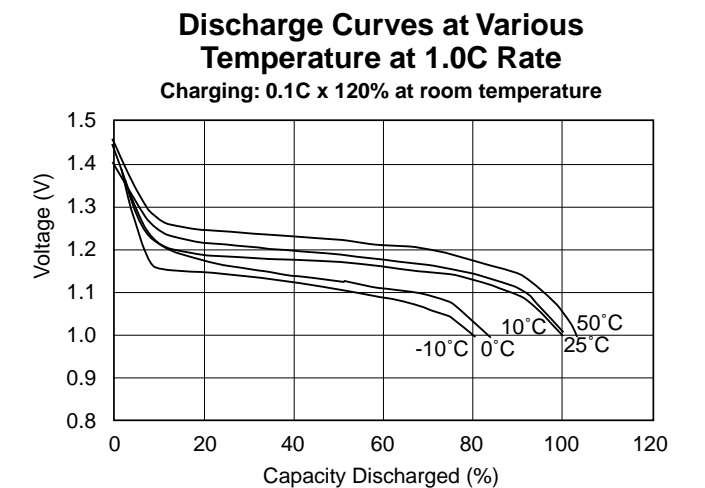

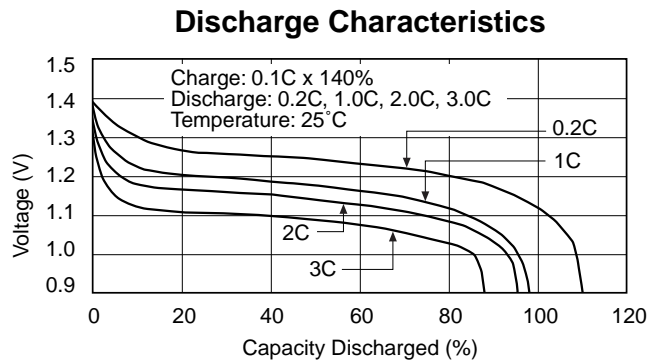

self-discharge currents inside the battery, as explained below:

**a. Decomposition of nickel hydroxide in the positive electrode:**

The nickel hydroxide is relatively unstable in a charged state and tends to return to a discharge state with the slow release of oxygen. The released oxygen then reacts with the hydrogen in the negative electrode, thus establishing an internal discharge path. The reaction rate increases with higher temperatures.

**b. Release of hydrogen from the negative electrode:**

There is a very low hydrogen equilibrium pressure for the metal-hydride electrode; such hydrogen reacts with the positive electrode. After consumption of the hydrogen, it is replenished from the metal-hydride electrode and the reaction continues at a steady rate. The reaction rate depends on the hydrogen equilibrium pressure, which is higher at increased temperatures.

**c. Side reactions through impurities:**

Some of the impurities can be oxidised in the positive electrode when it migrates to the negative electrode, where it reverts to its original form. The shuttle reaction of the impurities dissipates the battery's power during storage. The reaction rate is also temperature-dependent.

**2.3.2 Storage temperature**

As already mentioned, the self-discharge reaction rate increases with higher temperatures. Prolonged storage of the battery at elevated temperatures will result in the battery material deteriorating faster; leakage performance will also deteriorate, resulting in a reduced battery lifetime. It is recommended that, for long storage, batteries should be kept at room temperature or below.

**2.3.3 Storage time**

As the battery loses energy during storage, the voltage also drops. In general, the battery capacity loss due to self-discharge during storage can be recovered by recharging. If the battery is stored for over six months it is advisable to cycle the battery several times to resume the battery capacity.

**2.3.4 Storage humidity**

Leakage and rusting of metal parts are accelerated in high humidity environments, especially those with correspondingly high temperatures. The recommended humidity level for battery storage is a maximum of 60% RH.

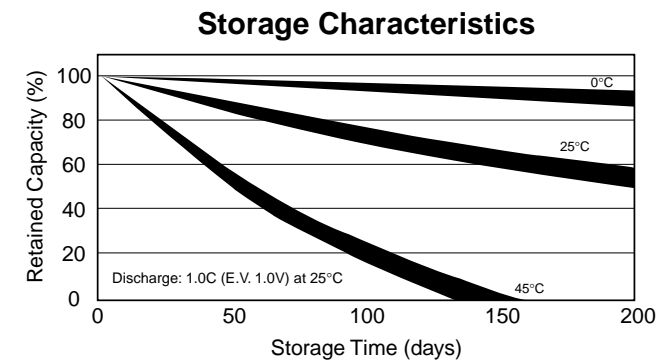

**2.4.3 Overcharge**

The cycle life of the battery is sensitive to the amount of overcharge at high charge rate. The amount of overcharge affects cell temperature and oxygen pressure inside the battery. Both factors deteriorate the metal-hydride electrode through oxidation and thus the cycle life shortens. For that reason the cycle life is affected by various charge cut-off methods.

**2.4.4 Deep discharge**

The cycle life is also affected by the depth of discharge. The number of charge/discharge cycles will decrease if the battery is repeatedly subjected to deep discharging below 1V, or to a status of polarity reversal. Considerably more cycle numbers can be obtained if the battery is cycled under shallower cycling conditions.

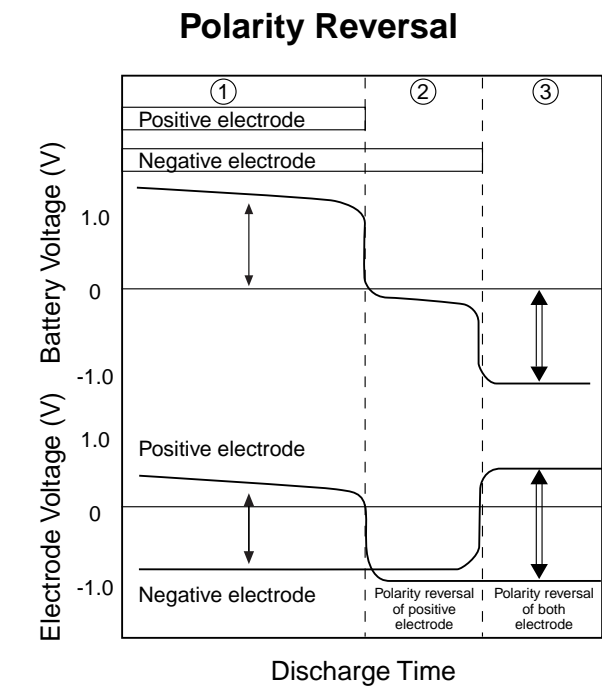

To avoid deep discharging, the capacity variation of the battery pack's unit cells should be kept to a minimum. It is also recommended that the discharge end voltage should be maintained at 1.0V times the number of unit cells connected in the battery pack. For battery packs connected with more than 8 cells in series, the recommended discharge end voltage is 1.2V times the number of cells, less by one.

**2.3 Storage Characteristics**

**2.3.1 Overview**

The battery loses its energy during storage, even without loading. The energy is lost through small,

**2.4 Cycle Life**

**2.4.1 Overview**

Cycle life is the number of charges and discharges a battery can achieve before the discharge capacity (0.2C) drops to 60% of the nominal capacity per IEC 61951-2 or other guaranteed value per GP specifications. Cycle life is affected by ambient temperature, as well as depth of charge and discharge. A common phenomenon to the NiMH battery is that the impedance increases upon cycling due to electrolyte dry-out, especially at the end of the cycle life. During overcharging, gases form and pressure builds up inside the battery; trace amounts of gas escape through the seal or vent hole, leading to moisture loss and separator dry-out. Actually, NiMH battery can attain 500-1000 cycles with cycling conditions of 0.1C charge/0.2C discharge.

**2.4.2 Ambient temperature**

It is recommended to cycle the battery at room temperature. At higher temperatures, the electrodes as well as the separator material deteriorate much faster, thus shortening the cycle life. At lower temperatures, the rate of oxygen recombination during overcharge is slow, and may risk opening the vent leading to pre-mature electrolyte dry-out.

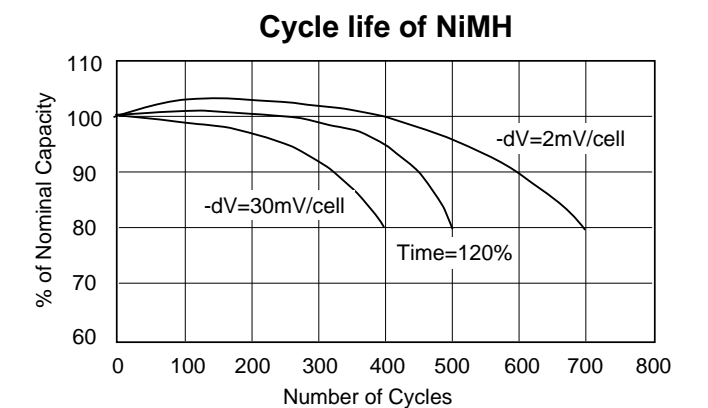

**2.5 Safety**

If pressure inside the battery rises as a result of improper use, such as overcharge, short circuit, or reverse charging, a resealable safety vent will function to release the pressure, thus protecting the battery from bursting.

**2.6 Characteristics of Various Series**

GP NiMH rechargeable batteries had long been established as a well-known choice that offers performance, reliability and value. In order to widen

# 3 Charging Method

its field of applications and extend its full advantages, we have expanded our NiMH product range into various series to custom fit various application requirements.

## 2.6.1 Standard Series

Our standard series is designed for a wide variety of general applications, which features a combination of superior positive and negative electrode, allowing us to provide the highest levels of capacity and quality for each size. These NiMH batteries also feature excellent discharge performance, low internal resistance and reliable characteristics across a wide range of temperatures, and they have been carefully designed for safety and reliability. Ranging from compact sizes to large sizes, the standard series is available in a wide selection of discharge capacities based on the standard sizes specified in IEC61951-2.

## 2.6.2 High Drain Series

Our high drain series is expertly customized for powerful delivery of electrical energy on demand. It was developed through an integration of our comprehensive NiMH battery technology. Improvements in the positive and negative electrode technology, and in the current collecting system have further lowered the internal resistance and greatly enhance the 10C discharge characteristics of the high drain series batteries.

**Discharge Curves of High Drain Series at Various Rates**

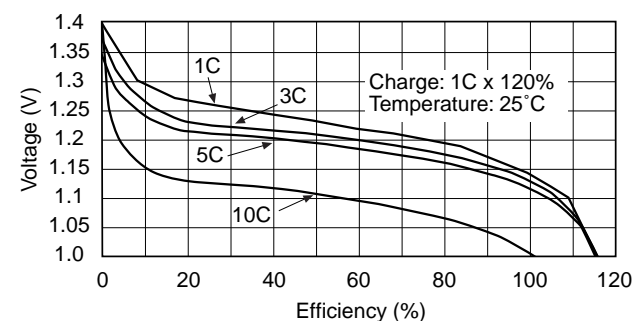

- Excellent high current discharge characteristics. It is designed to meet the need for high current discharge, such as for power tools, and can deliver a high current exceeding 10C.

- Reliable, long cycle life

In addition to excellent high rate discharge performance, high drain series batteries also provide hundreds of charge/discharge cycles, showing reliable cycle life characteristics.

## 2.6.3 High Temperature Series

With standard series NiMH batteries, the smaller the charging current and the higher the charging temperature, the more difficult for it to charge the battery. However, for applications in which the batteries are charged continuously by a small current under relatively high temperature conditions such as emergency lights, there is a need for superior high temperature trickle charge performance. By combining GP's technology in electrodes and electrolyte, high temperature series NiMH batteries are far superior to the standard series NiMH batteries for use in high temperature trickle charge applications. Furthermore, the use of a special separator provides stable trickle charge life characteristics.

**Charge / Discharge Characteristics of High Temperature Series**

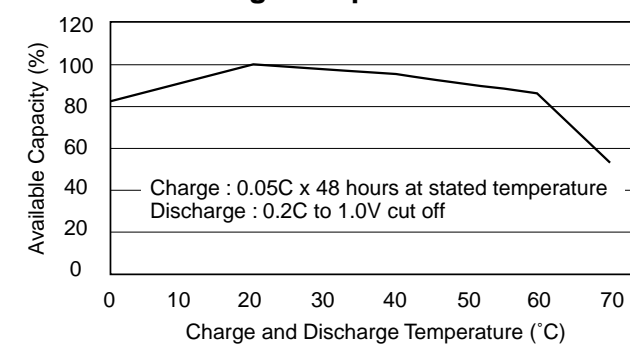

**Life Expectancy**

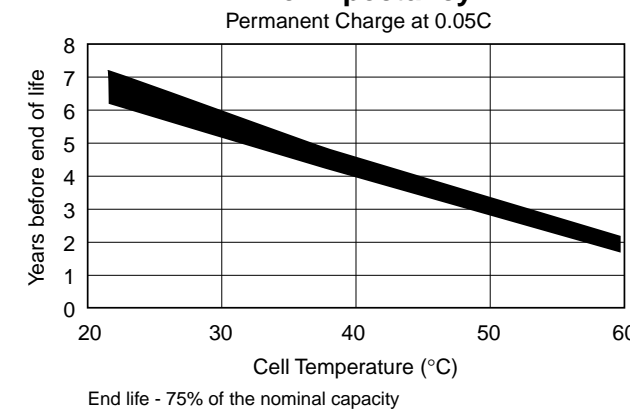

## 3.1 Overview

One crucial difference between the primary and secondary battery is the ability to restore energy after discharging. This restoration of energy is therefore a very important area to be considered in secondary battery applications. Since different battery systems have their own characteristics and applications have their own integrated electrical input/output requirements, it is vital to select a charging method that suits both the battery system and the application. Improper charging will lead to poor battery performance or failure of the application.

## 3.2 Charging Method

Like NiCd, the main concern in charging a NiMH battery is the build-up of temperature and internal pressure due to high overcharge rates. As previously mentioned, the cell design applies the concept of oxygen recombination in lowering the battery's internal oxygen level during standard charging. However, if the cell is subjected to severe charging conditions (such as overcharging at a current rate over 1C), the rate of oxygen evolution from the positive electrode increases rapidly, exceeding the recombination reaction rate. As the oxygen recombination reaction is exothermic, this results in excessive oxygen pressure and increased temperature. The excessive pressure will then be released through the safety vent causing a reduction in the cell electrolyte; the excessive heat will eventually degrade the cell's internal contents. These two factors are considered to be the major limitations to the battery's service life. For this reason, charge control is very important in battery charging. GP NiMH cylindrical cells are designed to be able to charge up to 1C rate. For applications that require higher charging rates, please contact GP.

In secondary battery charging the two most commonly used methods are constant voltage charging and constant current charging. As with

the NiCd system, constant voltage charging is not recommended for NiMH, due to thermal runaway under overcharging conditions. As mentioned earlier, the heat generated by the overcharge current can cause a significant rise in battery temperature, which will cause a drop in the battery charging voltage. In constant voltage charging, the overcharge current is determined by the potential difference between the power source and the battery charging voltage. The increased difference between the power source and the battery charging voltage, due to the temperature rise, will also augment the overcharge current. This increase in the overcharge current will lead to a further increase in cell temperature. This positive feedback cycle of cell temperature and overcharge current will not run down until the battery fails or until the current limit of the charger is reached. For this reason, constant voltage charging should not be used in charging NiMH batteries, and charge control should be employed if this method cannot be avoided.

### 3.2.1 Constant current charging

The advantages of the constant current charging method include high charging efficiency, flexibility, and position control of input capacity.

### 3.2.2 Fast charging

GP NiMH batteries use constant current charging as the basis of the charging method. Depending on different operational requirements, constant current charging can be further classified according to the charging rate. Charging at a current rate of 0.5C to 1C, or higher (up to 3C), is considered fast charging. As explained earlier, if the charging current is too high (1C or above), the cell internal pressure and temperature will rise at the end, resulting in degraded cell performance and electrolyte leakage.

### 3.2.3 Charge control

Various methods are recommended to help control charging, so as to prevent gas pressure and temperature build-up due to overcharging. Proper charge control will provide a longer battery service life.

# 4 Battery Assembly

## a) dT/dt control

The detection of the rate of temperature rise when the battery approaches a state of full charge (dT/dt control) is considered to be the best form of charge control. When charging at a current rate of 0.5C to 0.9C, a temperature rate change of 0.8°C/min. is recommended for charge termination; for 1C to 3C a higher rate of 0.8-1°C/min. should be chosen.

## b) -dV control

Detecting the value of the voltage drop after reaching peak voltage is the most commonly used charge control method in fast charging GP NiMH batteries. A -dV value of 0-5mV/cell is recommended when fast charging GP NiMH batteries, while a -dV value of 2mV/cell is found to provide the best balance between charge termination and service life performance.

## c) Charging time control (back up only)

An easier way to control fast charging of GP NiMH batteries is to control the elapsed time following commencement of charging. However, it is not recommended as the only cut-off method due to overcharging. A charging time equal to 105% of the cell nominal capacity is recommended.

## d) Battery temperature control

As increased ambient and cell temperatures result in high cell internal pressure, it is highly recommended to have temperature control backup for safety and cell performance. When fast charging GP NiMH batteries, the cut-off temperature is recommended to be controlled at 45-50°C.

## 3.2.4 Standard charge

Apart from fast charging, GP NiMH batteries can also be charged at a lower current rate of 0.1C. As this charging method is less severe, charge termination at 160% nominal capacity input is recommended (to help avoid extended overcharging of the battery). Also, in some applications where overcharging is necessary, GP NiMH batteries can endure 0.1C continuous charging for about one year.

## 3.2.5 Trickle charging

In most applications - where cells and batteries need to be in a fully charged condition - maintaining a trickle charge current to compensate for the loss of capacity (due to self-discharge) is recommended. The suggested trickle charge current to be used is 0.05C to 0.1C.

## 3.2.6 Charging temperature

As ambient temperature affects charging efficiency and cell reliability, it is important to select a suitable temperature for optimising charging performances. Generally speaking, a temperature within 10°C to 45°C will yield the highest efficiency, which begins to drop at or above 45°C. Conversely, repeated charging at less than 0°C may cause cell internal pressure build-up, resulting in electrolyte leakage as in high temperature conditions. For these reasons, GP NiMH batteries can be charged at temperatures of 0°C to 45°C under standard charging conditions, but preferably at 10°C to 45°C under fast charging conditions

## 4.1 Connections Between Cells

The resistance spot-welding method is to be used when NiMH cells are connected in a series, to avoid an excessive increase in cell temperature, which would occur if soldered on directly. Leads used for cell connections should be nickel-plated or pure nickel measuring 0.1mm to 0.4mm in thickness and 3mm to 6mm in width.

The temperature of NiMH cells rises when the charge gets close to completion. Temperature increase is greater for a battery pack than for a single cell, due to the fact that the pack does not really allow for the dissipation of heat. The problem is further exacerbated when the pack is enclosed in a plastic case. Air ventilation should be provided in the plastic case of batteries – to allow for egress of any gases that may result from activation of the safety vent of cells after abuse.

## 4.2 Thermal Protection for Battery Packs

Battery packs intended for fast charging methods should have a thermal protection device. A thermistor sensing the temperature inside the pack should be employed. It is also desirable to have a thermostat/polyswitch and a thermal fuse installed in the battery pack to protect it from abnormal rises in temperature and external short-circuiting. Locations for safety devices in battery pack assembly are shown in the following diagrams.

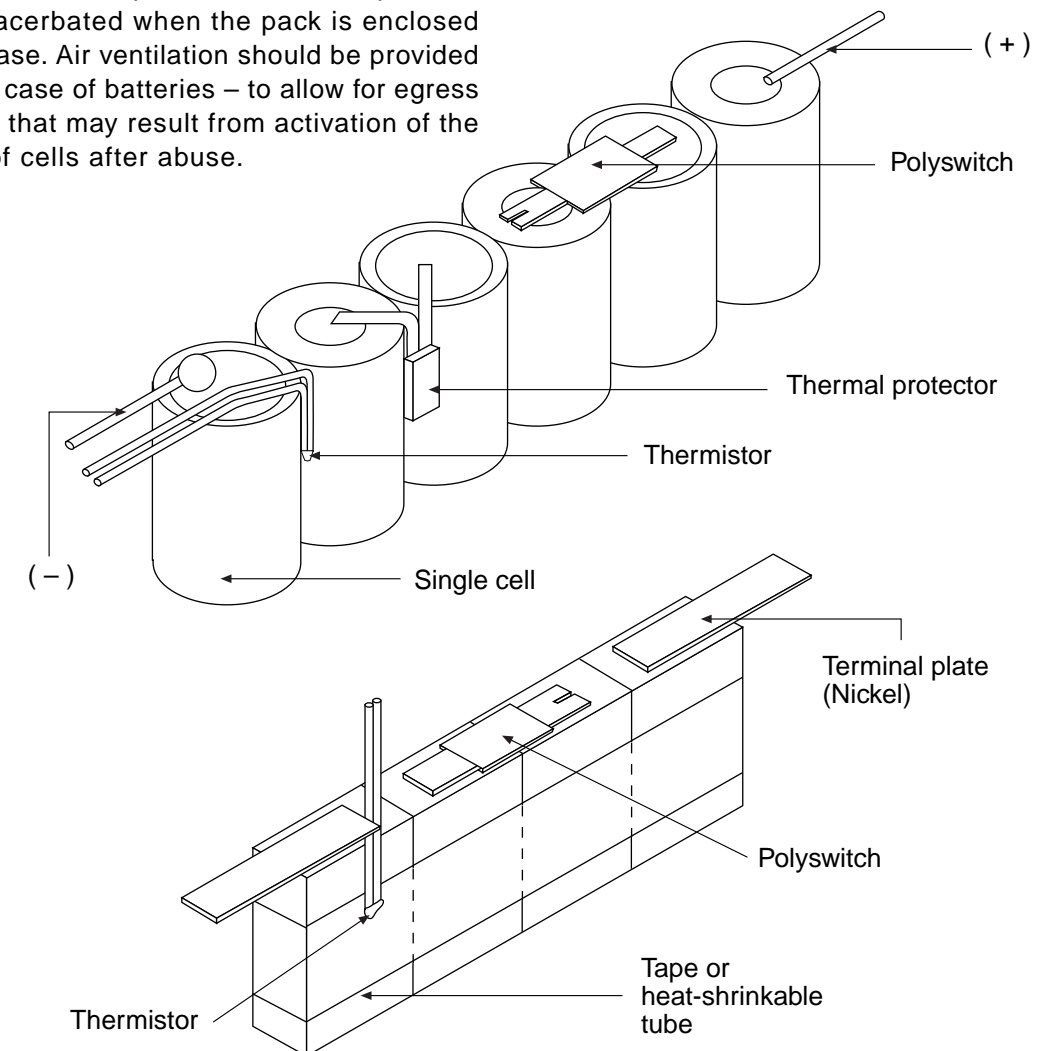



# 5 Configurations



## Designation System for Battery Packs

An example:

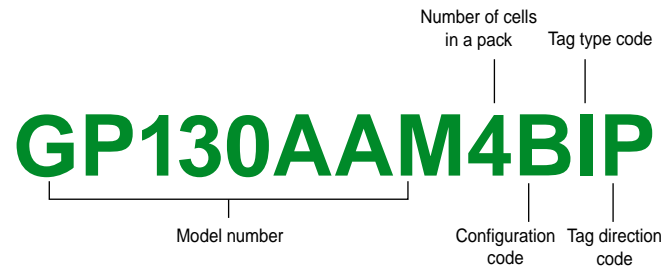

For battery packs with connectors, the last two characters will be used to specify connector type eg. GP130AAM4BMU.

### Standard Configurations for Battery Packs

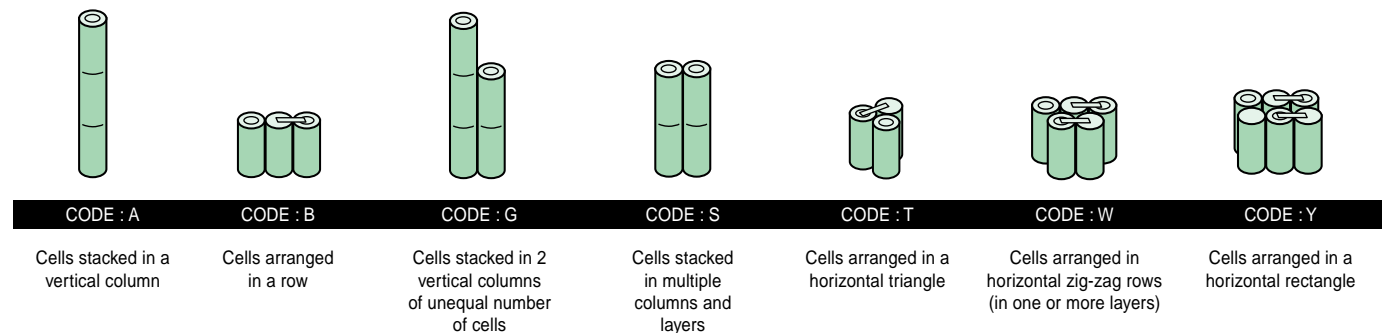

### Tag Type Specifications

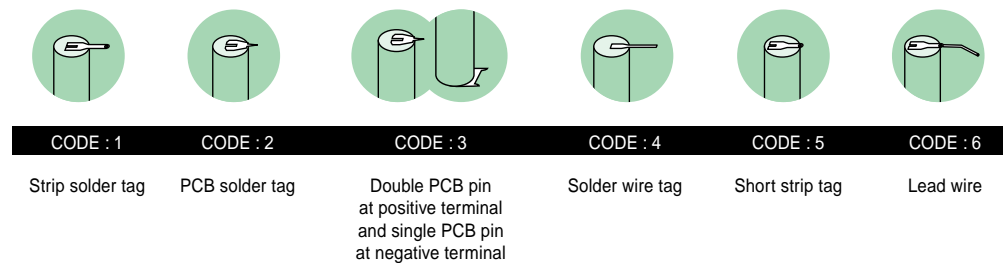

### Tag Direction Codes

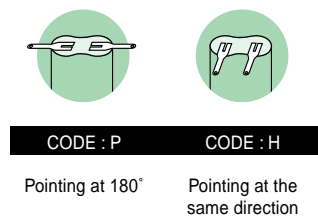

### Connector Type Specifications

GP Universal Plug - exclusively from GP, offers distinctive features unparalleled in the market.  
- U.S. patent no. 5,161,990.

#### Major Benefits

- Compatible with most cordless phone models (interchangeable with Mitsumi, JST, Molex plugs etc.)
- Minimise inventory items
- User friendly

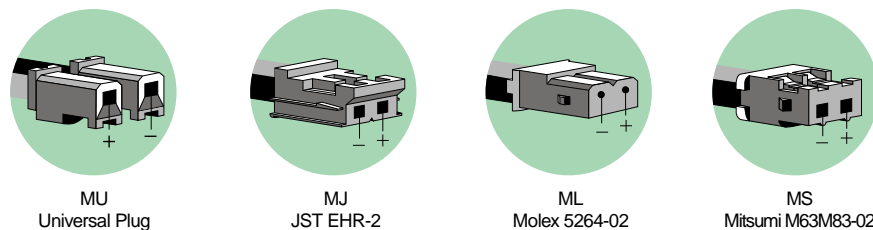

# 6 Proper Use and Handling

## 6.1 Restriction on Usage

Knowledge of battery maintenance is crucial to a working battery, helping to provide a longer period of operation. On the other hand, improper battery handling or maintenance may lead to unnecessary battery defects or problems, such as electrolyte leakage or cell bulging. In order to get the most out of using GP NiMH rechargeable cells, special care in the following areas should be considered:

### 6.1.1 Charging / discharging current

For fast charging GP NiMH batteries, the current rate should be 0.5C to 1C. Trickle charging, which is common in various applications (such as memory backup), requires a current charging range of 0.05C to 0.1C to maintain the long-term standby power of the battery. In addition, GP NiMH batteries can be trickle-charged at 0.1C continuously for one year without leakage or explosions. Charging current rates higher than 1C are generally not recommended. However charging with pulses higher than 1C is not uncommon in some applications. Please contact authorised GP personnel to determine the applicability of special charging schemes not mentioned in GP product specifications.

Special attention should be paid to the charge termination method, which is a critical element in providing an optimised cycle life, yet one which is easily overlooked. Several charging cut-off mechanisms with related parameters can be considered:

Negative delta voltage:	0-5mV
dT/dt:	0.8°C/minute (0.5C to 0.9C)
	0.8-1°C/minute (1C)
Temperature control:	45-50°C
Timer control:	105%

These charging cut-off mechanisms can be incorporated into the application – either together or individually, with the choice of method depending largely on the charging profile of the application. To avoid unnecessary battery problems, which might look like quality issues, please contact authorized GP personnel for implementing the appropriate charging cut-off method.

A wide range of required discharge current rates will be encountered in different applications, and GP has a variety of battery types for specialised use. Apart from the standard series for general applications, high temperature and high drain series are specially designed for applications in high ambient temperatures and discharge current rates respectively. The maximum discharge current recommended for batteries of standard series is generally 3C. However, there are situations where higher currents of shorter duration are permissible.

### 6.1.2 Reverse charging

Reverse charging is one of the battery misuses that can appear to be a battery defect. If the positive and negative polarities are reversed when charging, the battery might bulge due to internal gassing. Electrolyte leakage consequently results due to venting at the safety valve, which leads to a decrease in capacity. Caution has to be exercised to avoid such misuse.

### 6.1.3 Parallel charging

Parallel charging is generally not recommended, please consult authorized GP personnel for possible exceptions to connecting the batteries in parallel charging.

### 6.1.4 Charging / discharging temperature

It is important to understand how ambient temperature affects the charging and discharging of batteries, especially for obtaining maximum efficiency in conditions that exceed room temperature. GP recommends the following temperature range.

Standard, high drain and high capacity series - cylindrical / prismatic / 9V

Standard charge:	0°C to 45°C
Fast charge:	10°C to 45°C
Discharge:	-20°C to 50°C
Storage:	-20°C to 35°C

High temperature series - cylindrical

Standard charge:	0°C to 70°C
Discharge:	-20°C to 70°C
Storage:	-20°C to 35°C

Using or storing the battery beyond the recommended temperature range leads to deterioration in performance. For example: leakage, shortening of battery life, and lowering of charging efficiency may occur at higher temperatures.

At sub-zero temperatures, discharge capacity will decrease due to lower mobility of the ions inside the battery.

### 6.1.5 Over-discharging / overcharging

Other than discharging C-rate and temperature, another factor affecting battery life and performance is the discharge cut-off voltage. An appropriate choice of end voltage not only determines the battery performance, it also provides the bottom line to avoid over-discharging the battery. GP recommends 1V/cell as the end voltage in most situations. However, there are occasions when slightly higher than 1V/cell is necessary (to avoid scenarios such as over-discharge, when the number of batteries in the series is large). In addition, discharge cut-off lower than 1V/cell should be considered especially when the discharge rate is very high.

Overcharging also adversely affect battery life, the major cause of which is the extra heat generated by overcharging. When overcharging repeats from cycle to cycle, the accumulated heat will eventually degrade the battery life. Therefore, incorporating a proper charging cut-off mechanism is a critical element in ensuring a long battery life.

## 6.2 Precautions for Designing Application Devices

### 6.2.1 Battery compartment

Bear in mind that there is always a chance of battery abuse, where internal gassing is highly probable; and as a result, the gas will be released through cell venting. However, generation of hydrogen gases from overcharging is particularly dangerous when mixed with oxygen. Caution should be focused on the ventilation of battery compartments. Airtight battery compartments are strongly discouraged. Ventilation should be provided in the plastic case of batteries, otherwise oxygen and hydrogen gas generated inside can cause explosion when exposed to fire sources such as motors or switches.

### 6.2.2 Charging / discharging / operating temperature

To optimise battery performance and service life, certain aspects related to charging, discharging and the operating temperature should be taken into careful consideration. A customer application questionnaire is provided in this technical handbook. Please provide as much information as possible. Alternatively, contact authorized GP personnel for advice and help with your application.

## 6.3 Methods of Use

### 6.3.1 Operation

Avoid combining used and fresh batteries, or batteries at different state-of-charge, which may lead to electrolyte leakage. Always cycle the battery several times to restore its capacity if the battery has been stored for an extended period of time.

### 6.3.2 Connection between battery and application devices

Be sure to connect the positive and negative battery terminals to the corresponding terminals of the application device, in order to prevent reverse charging.

## 6.4 Precautions in Battery Handling

- Never incinerate the battery.
- Never solder a battery directly.
- Avoid subjecting a battery to strong vibrations, pressure or impact.
- Never connect the battery terminals to the device without verifying the polarities.
- Never carry a battery with other metallic belongings to avoid short-circuiting.
- Never disassemble a battery.
- Never mix GP batteries with other battery brands or batteries of a different type.
- Never short together the positive and negative terminals of a battery with any metal.
- Never obstruct the safety vent, which is located near the positive terminal of the cylindrical/prismatic cell, and on the positive side of the button cell -indicated by a vent mark.
- Never alter the factory-configuration or remove/modify a component of a battery.
- Never charge/discharge a battery under conditions which are not within GP specifications, or without consulting authorized GP personnel on special applications.
- Never use other charger than specified to avoid possible heating, burning or rupture.
- Never leave a battery connected to a device for long periods without charging the battery, especially for devices that constantly drain standby current.
- If any abnormality or problem is found while using the battery, stop its use, and bring it to your local dealer.
- Never use cells or batteries for any other applications than specified, that may result in damage to the batteries and the appliances.

## 6.5 Battery Maintenance

### 6.5.1 Regular inspection

Periodic visual inspection of the battery is recommended. It is also advisable to store the battery at room temperature, with low humidity, when the battery is not expected to be used for a long period of time; the aim of which is to prevent cell leakage and rust.

### 6.5.2 Storage

Bear in mind that self-discharge has to be taken into consideration when storing a charged battery. The remaining battery capacity should be at least 50% after a month of storage at room temperature for a fully charged battery. High storage temperatures will accelerate the self-discharge, and reduce the remaining capacity.

In order to maintain battery performance when being stored for an extended period of time, cycling (charging and discharging) of the battery within a 6 to 9 month period is recommended. This procedure is recommended to maximize performance of the battery and prevent low OCV in long-term storage conditions. Failure to do so may result in a shorter battery life.

### 6.5.3 Battery disposal

Under normal conditions, when the battery has reached its end of life, it is advisable to properly insulate the positive and negative terminals of the battery prior to disposal. Please note that it is dangerous to dispose of the battery in fire, as it will lead to electrolyte spill-out and bursting of the battery.

Recycling of the battery is an important environmental issue nowadays. We recommend you contact your local government concerning the location of recycling sites, or enquire about local regulations on methods of disposal for NiMH batteries in your region.

### 6.5.4 Transportation

GP NiMH batteries should not be thought of as wet batteries (like traditional, non valve-regulated batteries). As a result, GP batteries can be shipped or transported in normal packaging without special hand.

# 7 Customer Application Questionnaire

## I. Customer Information

Customer: \_\_\_\_\_  
 Address: \_\_\_\_\_  
 City: \_\_\_\_\_ Contact person: \_\_\_\_\_  
 State: \_\_\_\_\_ Electrical: \_\_\_\_\_ Title: \_\_\_\_\_ Email: \_\_\_\_\_ Tel: \_\_\_\_\_  
 Zip: \_\_\_\_\_ Mechanical: \_\_\_\_\_ Title: \_\_\_\_\_ Email: \_\_\_\_\_ Tel: \_\_\_\_\_  
 Fax: \_\_\_\_\_ Commercial: \_\_\_\_\_ Title: \_\_\_\_\_ Email: \_\_\_\_\_ Tel: \_\_\_\_\_

**Cap#** \_\_\_\_\_  
 Customer: \_\_\_\_\_  
 Salesperson: \_\_\_\_\_  
 Sales Order# \_\_\_\_\_ Date: \_\_\_\_\_

## II. Product Description

A. Model No.: \_\_\_\_\_ Capacity: \_\_\_\_\_ mAh Voltage: \_\_\_\_\_ V  
 B. Application: \_\_\_\_\_ Qty/year: \_\_\_\_\_ Tentative production date: \_\_\_\_\_  
 C. Sample request: Cell qty: \_\_\_\_\_ Quote: \_\_\_\_\_ Requested delivery date: \_\_\_\_\_  
 Pack qty: \_\_\_\_\_ Testing: \_\_\_\_\_  
 D. Type of designs:  Preliminary  Mechanical only  Electrical only  Final  
 E. Ship to:  Salesperson \_\_\_\_\_  
 Others  
 Name: \_\_\_\_\_ Company: \_\_\_\_\_  
 Address: \_\_\_\_\_  
 City: \_\_\_\_\_ State: \_\_\_\_\_ Zip: \_\_\_\_\_  
 F. Specifications: (from customer)  
 Customer drawing: \_\_\_\_\_  Customer sample(s): \_\_\_\_\_ (pcs).  
 Parts & assembly drawing: \_\_\_\_\_  Circuit diagram: \_\_\_\_\_  Bill of material: \_\_\_\_\_  
 Written specification: \_\_\_\_\_ Title: \_\_\_\_\_ Date: \_\_\_\_\_  
 Others: (please specify) \_\_\_\_\_

Sketch

Details:  
 1. Show all critical dimension with tolerance or max.  
 2. Show connector polarity.  
 3. Show label orientation.  
 4. Show and list any special features or materials.

### G. Protection/Safety:

- Customer will protect battery externally.  
 Built-in protection requirements

Component	Short circuit	Overcharge	Rating	Manufacturer	Model no.
Polyswitch:	_____	_____	_____	_____	_____
Thermostat:	_____	_____	_____ °C	_____	_____
Thermistor:	_____	_____	_____ Ohms	_____	_____
Thermal fuse:	_____	_____	_____ °C/Amps	_____	_____
Current fuse:	_____	_____	_____ A	_____	_____
Others:	_____				

\*All Packs should be protected against short circuit and over charging.

\*Li-ion packs must have safety circuit to protect over charging.

\*Air ventilation should be provided in the plastic case of batteries, otherwise it may have a risk generating gases inside them (oxygen and hydrogen gas) resulting explosion triggered by fire sources (motors or switches). Caution should be focused on the ventilation of battery compartments. Airtight battery compartments are strongly discouraged.



H. Charging parameter

\*Fill out as much of the following table as possible.

**Cap#** \_\_\_\_\_  
 Customer: \_\_\_\_\_  
 Salesperson: \_\_\_\_\_  
 Sales Order# \_\_\_\_\_ Date: \_\_\_\_\_

For NiCd & NiMH

Charge Mode	Charge		Termination					
	Constant current (mA)	Max. volts (V)	-Delta V (mV/cell)	DV/dt (mV/min)	TCO (°C)	DT/dt (°C/min)	Timer (hr)	Vmax (V)
Ultra Fast (>2C)								
Fast (>0.5C)								
Standard (0.1C)			N/A	N/A		N/A		
Trickle (<0.1C)			N/A	N/A		N/A	N/A	

For Li-ion

Charge Mode	Charge			
	Current to voltage limit (mA)	Voltage limit (V) (<4.2V/cell)	Time (hr)	Charge control chip
Standard (0.8C) to 4.2V		4.2	2.5	
Customer proposed				

Safety Protection					
Over charge limit (V)	Over discharge limit (V)	Over discharge current limit (A)	Over discharge current delay time (mins)	TCO (°C)	Timer (hr)

\*The method of charging and discharging Li-ion battery is very important to the safety and performance of the battery. Please consult engineer for optimal safety and performance.

For Smart Battery

Fuel Gauge Parameter Table (provided by customer)  
 IC Type (provided by customer)  
 Yes: \_\_\_\_\_ (please attached) No: \_\_\_\_\_  
 Remarks: \_\_\_\_\_

I. Discharge method

Discharge mode: Constant current \_\_\_\_\_ mA Battery low alarm voltage \_\_\_\_\_ mV  
 Average current \_\_\_\_\_ mA Discharging cut-off voltage \_\_\_\_\_ mV  
 Power \_\_\_\_\_ W Stand-by current after cut-off \_\_\_\_\_ mA  
 Resistance \_\_\_\_\_ Ohm  
 Discharge termination method: Cut off voltage \_\_\_\_\_ (V)

J. Operation temperature	Max.	Min.
In charge		
In discharge		
In storage		

K. Specific testing requirement:

Please describe \_\_\_\_\_

## III. Remarks

## IV. Approvals (GP internal use only)

Sales: \_\_\_\_\_ Engineering: \_\_\_\_\_

# 8 Glossary

## **Active Material**

Chemicals that give rise to electro-chemical reactions, and which generate electrical energy in the battery.

## **Alkaline Electrolyte**

An aqueous alkaline solution (such as potassium hydroxide) which provides a medium for the ionic conduction between the positive and negative electrodes of a cell.

## **Ampere-hour**

Unit of capacity of a cell/battery. Capacity is defined as the product of the discharge rate and the discharge time.

## **Battery**

Consists of one or more connected cells.

## **Capacity**

The amount of electrical energy that can be supplied by a cell/battery - expressed in mAh, and in specified discharge conditions.

## **Cell**

An electrochemical unit constituting positive and negative electrodes, separator, and electrolyte to provide electrical energy.

## **Cell Reversal**

In reversal, the normal terminal polarities of a cell in a multiple cell battery are switched. Cell reversal normally occurs only if three or more unit cells are connected, and the battery is deeply discharged. Cell reversal is detrimental to performance, and should be avoided by proper selection of cut-off voltages during discharge.

## **Charge**

The operation which inputs electrical energy to a cell/battery.

## **Charge Efficiency**

A measurement of accumulated efficiency during the charging operation.

## **Charge Rate**

The rate of current supplied to a cell/battery.

## **Charge Retention**

The percentage of capacity remaining after a charged cell/battery has been stored for a period of time.

## **Closed-circuit Voltage**

The voltage of the cell/battery with loading.

## **Constant Current Charging**

Charging with a fixed current value.

## **C-Rate**

Relative rate used in cell/battery, defined as the quotient of current (mA)/nominal capacity (mAh).

## **Cut-off Voltage**

A set voltage that determines when the discharging of a cell/battery should end.

## **Cycle Life**

The number of cycles a cell/battery can run under specific conditions, while still delivering specified minimum capacity.

## **Depth of Discharge**

The percentage of the available capacity from a cell/battery during discharge.

## **Discharge**

The operation which removes stored electrical energy from a cell/battery.

## **Discharge Rate**

The rate of current drained from a cell/battery.

## **Electrode**

A conducting plate containing active materials.

## **Exothermic Reaction**

A chemical reaction which results in the release of heat energy as it proceeds.

## **Memory Effect**

The phenomenon whereby the capacity of a cell may be temporarily decreased when it is repeatedly used in a shallow discharge pattern. Memory effects are erased when the cell is discharged to the normal cut-off voltage (e.g. 1.0V at the 0.2C discharge rate).

## **Negative Electrode**

The electrode with negative potential. Current flows through the external circuit to this electrode during discharge.

## **Nominal Voltage**

A general value to indicate the voltage of a battery in application.

## **Open-circuit Voltage**

The voltage of the cell/battery without loading.

## **Overcharge**

The continued charging of a cell/battery after it is fully charged.

## **Positive Electrode**

The electrode with positive potential from which current flows through the external circuit to the negative electrode during discharge.

## **Overcharge Current**

The charge current supplied during overcharge. Cells/batteries can accept continuous overcharging at recommended rates and temperatures specified by the manufacturer.

## **Rated Capacity**

A nominal capacity available from a cell at specific discharge conditions.

## **Safety Vent**

This is a device to release the gas when the internal pressure of the battery exceeds the pre-set value.

## **Self-discharge**

The loss of capacity by a cell/battery during storage or in an unused condition. The rate of self-discharge is affected by ambient temperature.

## **Separator**

The thin and porous membrane between the positive and negative electrodes to prevent short-circuit and hold the electrolyte.

## **Short Circuit**

The direct connection of the positive electrode/terminal to the negative electrode/terminal of the battery.

## **Standard Charge**

The normal charge rate used to charge a cell/battery in 16 hours. Normally 0.1C.

## **Thermal Fuse**

A component assembled into batteries, which breaks the current when the temperature reaches a predetermined value.

## **Thermistor**

A component with a negative temperature coefficient - built into batteries and/or used to detect the ambient and battery temperature.

## **Trickle Charge**

A continuous and very low rate charging to keep a cell/battery on full capacity.



# GP Batteries

## WORLDWIDE HEADQUARTERS

### Hong Kong

#### GPI International Limited

8/F., Gold Peak Building, 30 Kwai Wing Road, Kwai Chung, N.T., Hong Kong  
Tel : (852) 2484 3333 Fax : (852) 2480 5912  
E-mail address : gpil@goldpeak.com Website : www.gpbatteries.com.hk

#### SALES AND MARKETING BRANCH OFFICES

##### ASEAN

GP BATTERY MARKETING (SINGAPORE) PTE. LIMITED  
97 Pioneer Road, Singapore 639579  
Tel: (65) 6863 1534 Fax: (65) 6863 8669

##### MALAYSIA

GP BATTERY MARKETING (MALAYSIA) SDN. BHD.  
Lot 26, Jalan Pengapit 15/19, Shah Alam Industrial Estate,  
40000 Shah Alam, Selangor Darul Ehsan, Malaysia  
Tel: (60) 3 5512 5675 Fax: (60) 3 5510 4543

##### THAILAND

GP BATTERY MARKETING (THAILAND) CO., LIMITED  
3/F., VH Commercial Building, 23/1 Soi 9, Ngamwongwan Road,  
Nonthaburi 11000, Bangkok, Thailand.  
Tel: (66) 2 952 5323/5324 Fax: (66) 2 952 5322

##### TAIWAN

GP BATTERY MARKETING (TAIWAN) LIMITED  
Room 1200, International Trade Building, No.205 Sec.1,  
Tun Hua South Road, Taipei 10647, Taiwan R.O.C.  
Tel: (886) 2 2741 4919 Fax: (886) 2 2731 4868

##### CHINA

HUIZHOU CHAO BA BATTERY TECHNOLOGY CO., LTD.  
2/F., South of Hongye Industrial Building,  
Tianluo Mountain, 14th Industrial District, Huizhou City,  
Guangdong, China (Postal Code: 516003)  
Tel: (86) 752 282 8428 Fax: (86) 752 280 2872

##### HONG KONG

GP BATTERY MARKETING (H.K.) LIMITED  
8/F., Gold Peak Building, 30 Kwai Wing Road,  
Kwai Chung, N.T., Hong Kong  
Tel: (852) 2420 0281 Fax: (852) 2494 9349

##### KOREA

GP BATTERY MARKETING (KOREA) LIMITED  
4/F., Kunsul Hoekwan Building, 71-2 Non Hyun-Dong,  
Kang Nam-Gu, Seoul, South Korea  
Tel: (82) 2 549 7188/9 Fax: (82) 2 514 0623

##### U.S.A.

GOLD PEAK INDUSTRIES (NORTH AMERICA) INC.  
11235 West Bernardo Court, San Diego,  
CA 92127-1638, U.S.A.  
Tel: (1) 858 674 6099 Fax: (1) 858 674 6496

##### CANADA

GP BATTERY MARKETING INC.  
Unit 7, 7780 Woodbine Avenue, Markham,  
Ontario, Canada L3R 2N7  
Tel: (1) 905 474 9507 Fax: (1) 905 474 9452

##### LATIN AMERICA

GP BATTERY MARKETING (LATIN AMERICA) INC.  
8370 NW, 66TH Street, Miami, Florida 33166, U.S.A.  
Tel: (1) 305 471 7717 Fax: (1) 305 471 7718

##### EUROPE

GP BATTERY MARKETING (EUROPE) S.A.  
75 Zae Du Trou Grillon,  
91280 St Pierre Du Perray, Paris, France  
Tel: (33) 1 6989 6200 Fax: (33) 1 6989 6221

##### GERMANY

GP BATTERY MARKETING (GERMANY) GMBH  
Niederlörricker Str. 62, D-40667 Meerbusch, Germany  
Tel: (49) 2132 971504/5/6 Fax: (49) 2132 80145

##### POLAND

GP BATTERY (POLAND) SPÓŁKA Z O.O.  
ul. Słowicza 19, 02-170 Warszawa, Poland  
Tel: (48) 22 846 7525 Fax: (48) 22 846 7535

##### U.K.

GP BATTERIES (U.K.) LIMITED  
Summerfield Avenue, Chelston Business Park,  
Wellington, Somerset, TA21 9JF, U.K.  
Tel: (44) 1 823 660 044 Fax: (44) 1 823 665 595

##### ITALY

GP BATTERY MARKETING ITALY S.R.L.  
Via Enrico Fermi 8, 20090 Assago, Milano, Italy  
Tel: (39) 02 488 2512 Fax: (39) 02 488 0275/2865

##### SCANDINAVIA

CEBON AB  
Grimboäsen 5, 417 49 Gothenburg, Sweden  
Tel: (46) 31 558 600 Fax: (46) 31 556 813

Distributed by: